

20A, 100V - 200V Dual Common Cathode Schottky Rectifiers

FEATURES

- Low power loss, high efficiency
- Ideal for automated placement
- Guardring for overvoltage protection
- High surge current capability
- Compliant to RoHS Directive 2011/65/EU and in accordance to WEEE 2002/96/EC
- Halogen-free according to IEC 61249-2-21 definition

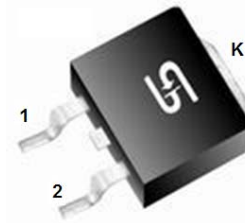

MECHANICAL DATA

Case: TO-263AB (D²PAK)

Molding compound, UL flammability classification rating 94V-0

Moisture sensitivity level: level 1, per J-STD-020

Part no. with suffix "H" means AEC-Q101 qualified

Packing code with suffix "G" means green compound (halogen-free)

Terminal: Matte tin plated leads, solderable per JESD22-B102

Meet JESD 201 class 2 whisker test

Polarity: As marked

Weight: 1.4 g (approximately)

TO-263AB (D²PAK)

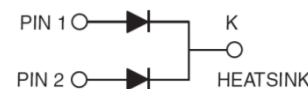

MAXIMUM RATINGS AND ELECTRICAL CHARACTERISTICS (T _A =25°C unless otherwise noted)					
PARAMETER	SYMBOL	MBRS 20H100CT	MBRS 20H150CT	MBRS 20H200CT	Unit
Maximum repetitive peak reverse voltage	V _{RRM}	100	150	200	V
Maximum RMS voltage	V _{RMS}	70	105	140	V
Maximum DC blocking voltage	V _{DC}	100	150	200	V
Maximum average forward rectified current	I _{F(AV)}	20			A
Peak repetitive forward current (Rated V _R , Square wave, 20KHz)	I _{FRM}	20			A
Peak forward surge current, 8.3 ms single half sine-wave superimposed on rated load	I _{FSM}	150			A
Peak repetitive reverse surge current (Note 1)	I _{RRM}	1	0.5		A
Maximum instantaneous forward voltage (Note 2) I _F =10A, T _J =25°C I _F =10A, T _J =125°C I _F =20A, T _J =25°C I _F =20A, T _J =125°C	V _F	0.85 0.75 0.95 0.85	0.88 0.75 0.97 0.85		V
Maximum reverse current @ rated V _R T _J =25°C T _J =125°C	I _R	5			μA
		2			mA
Voltage rate of change (Rated V _R)	dV/dt	10000			V/μs
Typical thermal resistance	R _{θJC}	1.5			°C/W
Operating junction temperature range	T _J	- 55 to +175			°C
Storage temperature range	T _{STG}	- 55 to +175			°C

Note 1: t_p = 2.0 μs, 1.0KHz

Note 2: Pulse test with PW=300μs, 1% duty cycle

ORDERING INFORMATION					
PART NO.	PART NO. SUFFIX	PACKING CODE	PACKING CODE SUFFIX (*)	PACKAGE	PACKING
MBRS20HxxxCT (Note 1)	H	RN	G	D ² PAK	800 / 13" Paper reel
		MN			800 / 13" Plastic reel

Note 1: "xx" defines voltage from 100V (MBRS20H100CT) to 200V (MBRS20H200CT)

*: Optional available

EXAMPLE					
PREFERRED P/N	PART NO.	PART NO. SUFFIX	PACKING CODE	PACKING CODE SUFFIX	DESCRIPTION
MBRS20H100CTHRNG	MBRS20H100CT	H	RN	G	AEC-Q101 qualified Green compound

RATINGS AND CHARACTERISTICS CURVES

(T_A=25°C unless otherwise noted)

FIG.1 FORWARD CURRENT DERATING CURVE

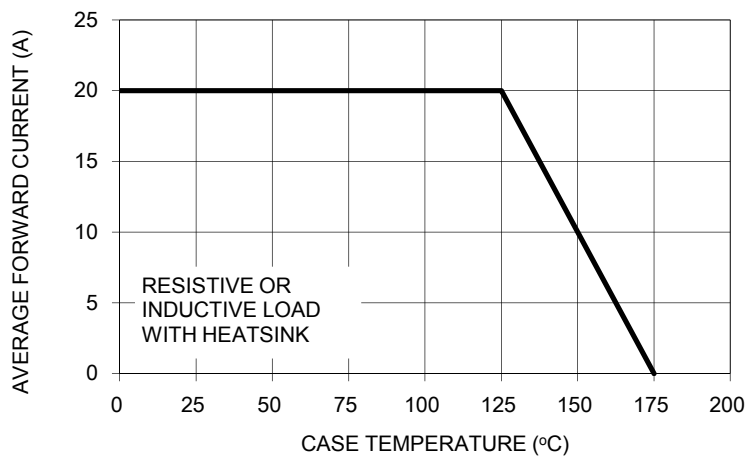

FIG. 2 MAXIMUM NON-REPETITIVE FORWARD SURGE CURRENT PER LEG

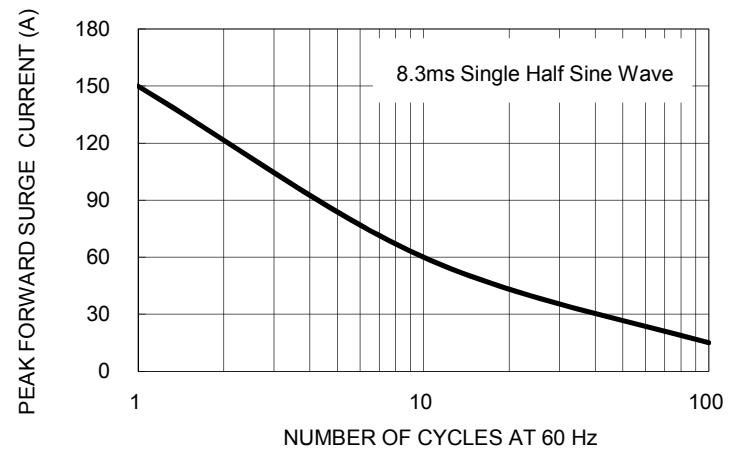

FIG. 3 TYPICAL FORWARD CHARACTERISTICS PER LEG

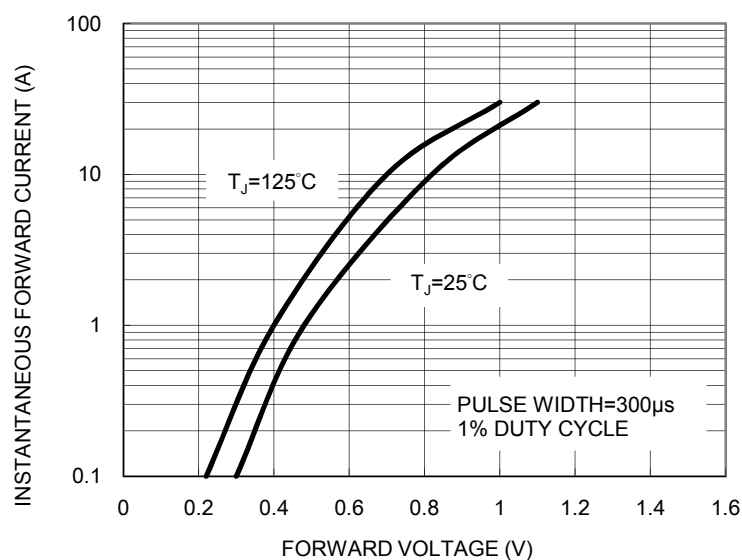

FIG. 4 TYPICAL REVERSE CHARACTERISTICS PER LEG

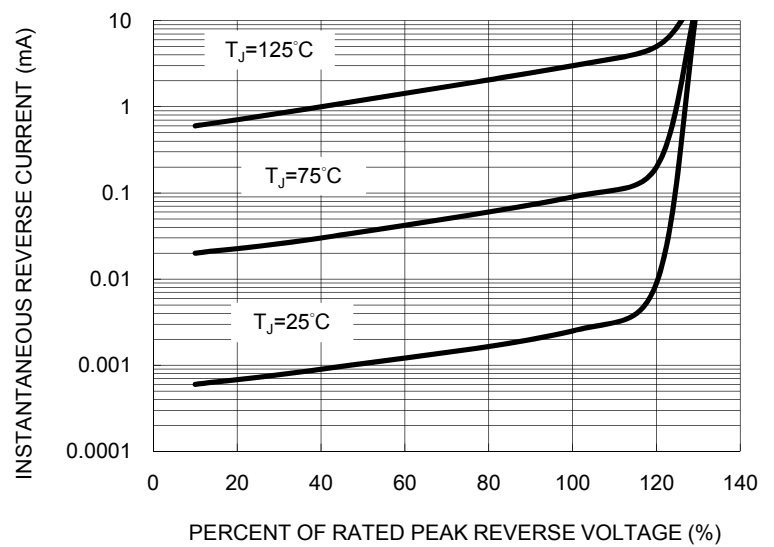

FIG. 5 TYPICAL JUNCTION CAPACITANCE

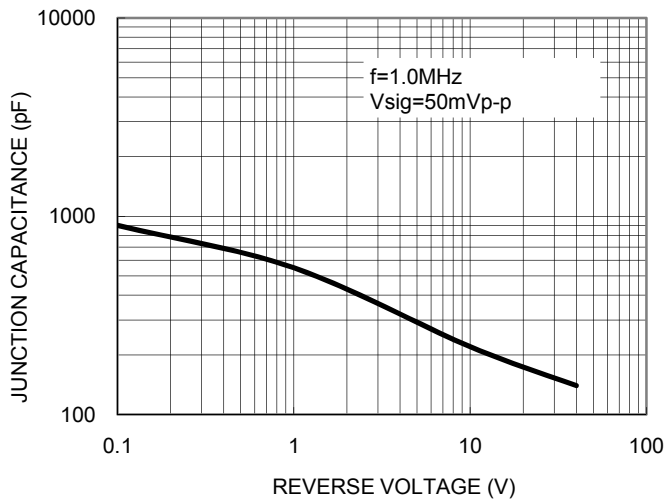
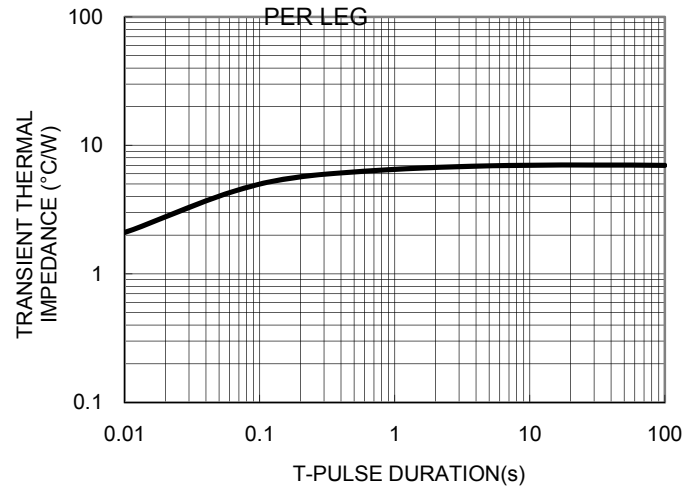
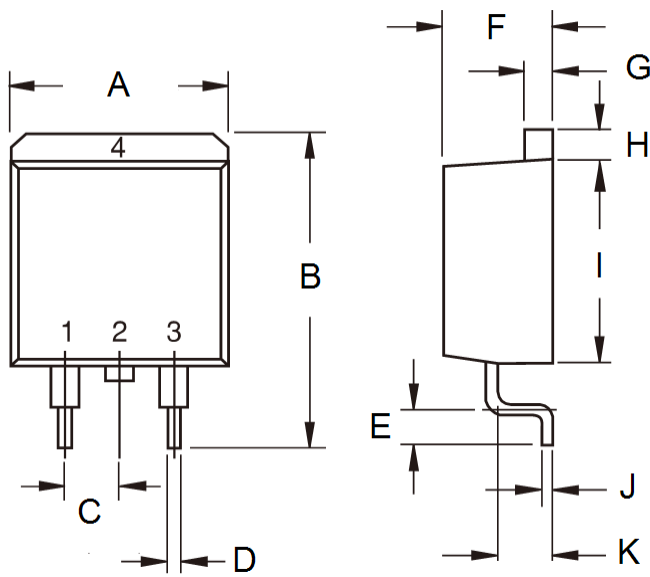

FIG. 6 TYPICAL TRANSIENT THERMAL IMPEDANCE PER LEG



PACKAGE OUTLINE DIMENSIONS

TO-263AB (D²PAK)



DIM.	Unit (mm)		Unit (inch)	
	Min	Max	Min	Max
A	-	10.5	-	0.413
B	14.60	15.88	0.575	0.625
C	2.41	2.67	0.095	0.105
D	0.68	0.94	0.027	0.037
E	2.29	2.79	0.090	0.110
F	4.44	4.70	0.175	0.185
G	1.14	1.40	0.045	0.055
H	1.14	1.40	0.045	0.055
I	8.25	9.25	0.325	0.364
J	0.36	0.53	0.014	0.021
K	2.03	2.79	0.080	0.110

SUGGESTED PAD LAYOUT

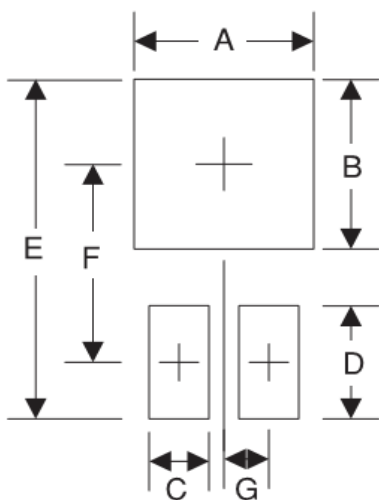

Symbol	Unit (mm)	Unit (inch)
A	10.8	0.425
B	8.3	0.327
C	1.1	0.043
D	3.5	0.138
E	16.9	0.665
F	9.5	0.374
G	2.5	0.098

MARKING DIAGRAM

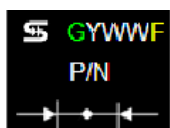

- P/N = Specific Device Code
- G = Green Compound
- YWW = Date Code
- F = Factory Code

Notice

Specifications of the products displayed herein are subject to change without notice. TSC or anyone on its behalf, assumes no responsibility or liability for any errors or inaccuracies.

Information contained herein is intended to provide a product description only. No license, express or implied, to any intellectual property rights is granted by this document. Except as provided in TSC's terms and conditions of sale for such products, TSC assumes no liability whatsoever, and disclaims any express or implied warranty, relating to sale and/or use of TSC products including liability or warranties relating to fitness for a particular purpose, merchantability, or infringement of any patent, copyright, or other intellectual property right.

The products shown herein are not designed for use in medical, life-saving, or life-sustaining applications. Customers using or selling these products for use in such applications do so at their own risk and agree to fully indemnify TSC for any damages resulting from such improper use or sale.

Mouser Electronics

Authorized Distributor

Click to View Pricing, Inventory, Delivery & Lifecycle Information:

Taiwan Semiconductor:

[MBRS20H100CT](#) [MBRS20H150CT](#) [MBRS20H200CT](#) [MBRS20H150CTHRNG](#) [MBRS20H200CTHRNG](#)
[MBRS20H200CTHRN](#) [MBRS20H100CT RNG](#) [MBRS20H150CT RNG](#) [MBRS20H100CTHRN](#) [MBRS20H100CTHRNG](#)
[MBRS20H200CT RNG](#) [MBRS20H100CT RN](#) [MBRS20H150CT RN](#) [MBRS20H100CT MNG](#) [MBRS20H100CTH](#)
[MBRS20H150CTH](#) [MBRS20H200CTH](#)